

S Sandberg®
ACTIVE 

Power Station AC 300

Quick guide

420-84



www.sandberg.world

Overview

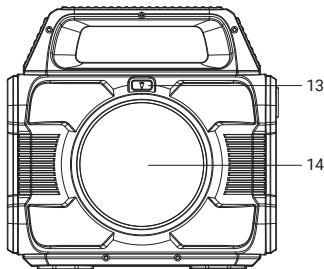
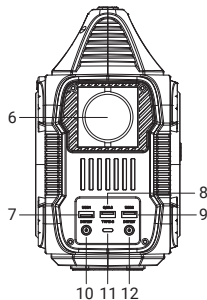
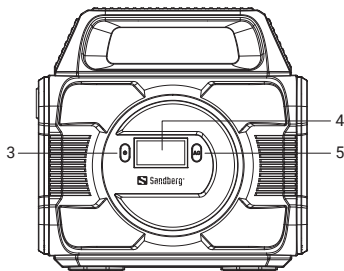
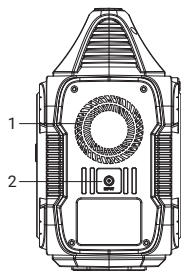

1. Cooling fan
2. DC Input
3. Power button
4. Digital Display Screen
5. AC Power button
6. AC Output
7. USB 1 Output
8. USB QC3.0 Output
9. USB 2 Output
10. DC 1 Output
11. USB-C Input/Output
12. DC 2 Output
13. LED light button
14. Lamp



Detailed specification

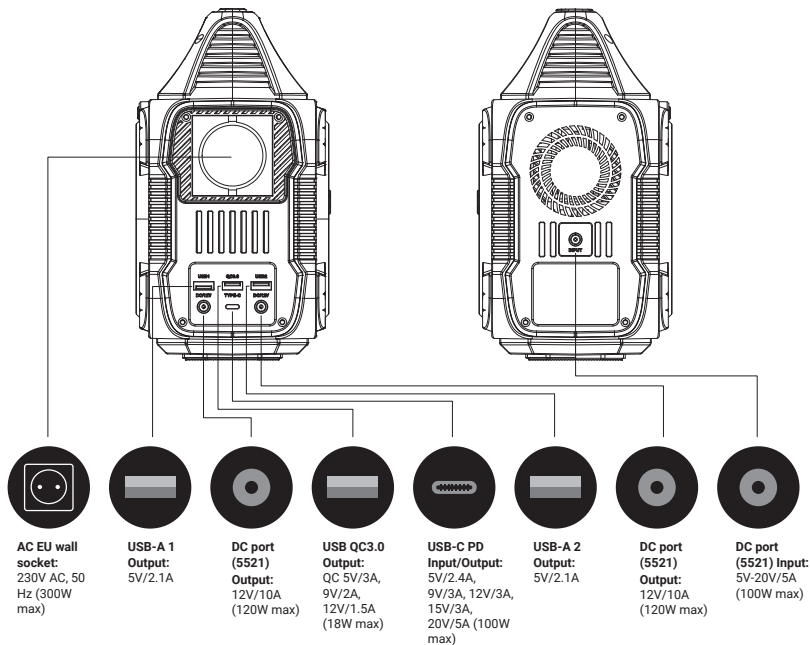

Button function



Press and hold power button for 5 seconds to turn on/off the device



Check the battery capacity



Press power button to turn on the DC Output

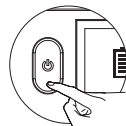
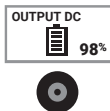

Press power button to turn off the DC Output



Press and hold AC power button for 5 seconds to turn on the AC Output

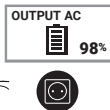

Press and hold AC power button for 5 seconds to turn off the AC Output

Charge the powerbank

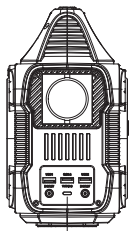

USB-C PD Input



DC port (5521) Input:
5V-20V/5A
(100W max)

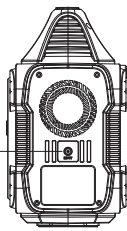

DC/PD Input

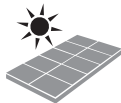

Solar Panel
Charger



Wall
Charger

**Charge mobile device
(USB 2 Output, USB QC3.0 Output and USB-C Output)**

Example of use

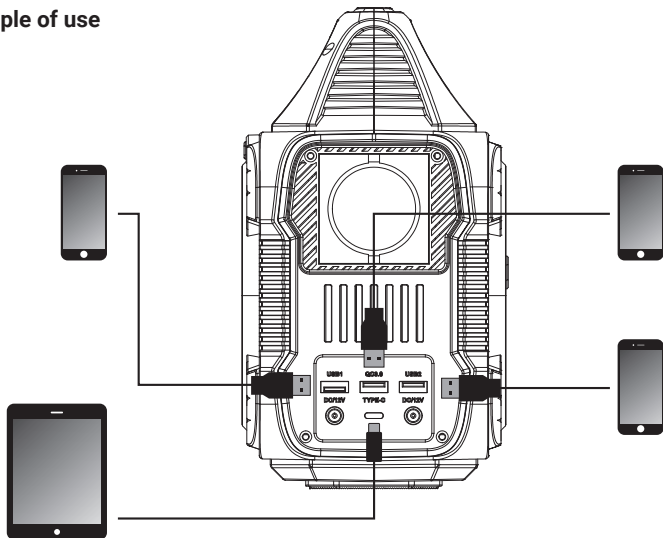

Charge equipment (AC Output)

Example of use

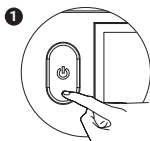
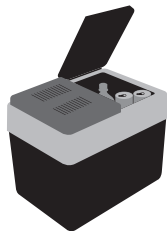

Press and hold power button for 5 seconds to turn on the device

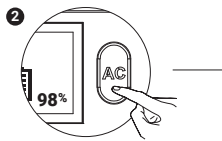

Press and hold AC power button for 5 seconds to turn on the AC Output

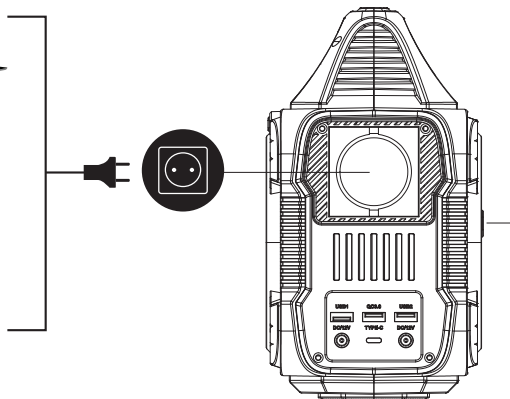

Lamp

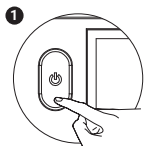

Press and hold power button for 5 seconds to turn on the device

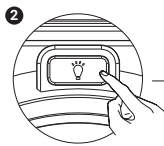

Press and hold LED light button for 5 seconds

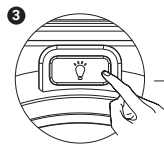
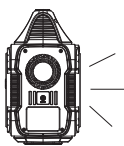

Press once more

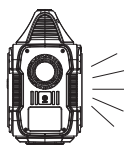

Press once more

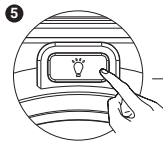
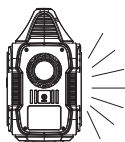

Press once more

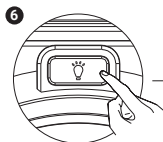
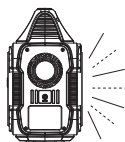

Press once more

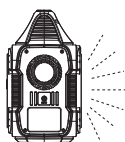

Press once more

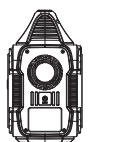

Warranty

There is a five-year warranty on your Sandberg product. Please read the warranty terms and register your new Sandberg product at www.sandberg.world/warranty

5
Years
Warranty

 Sandberg®

Power Station AC 300

Item no. 420-84

Li-Ion Battery capacity: 14.4V/20Ah/288Wh (3.6V/8000mAh/288Wh)

1 x AC EU-wall socket: 230V AC, 50 Hz (300W max)

1 x DC-port (5521) input: 5V-20V/5A (100W max)

2 x DC-port (5521) output: 12V/10A (120W max)

2 x USB-A output: 5V/2.1A Product weight: 2900g

1 x USB-A output: QC 5V/3A, 9V/2A, 12V/1.5A (18W max)

1 x USB-C PD in/out: 5V/2.4A, 9V/3A, 12V/3A, 15V/3A,
20V/5A (100W max)

www.sandberg.world info@sandberg.world

Sandberg A/S
Bregnerødvej 133D,
3460 Birkerød, Denmark

Made in China

UN38.3



NOTE: For optimal battery performance, we recommend fully discharging and recharging the powerbank at least once every three months.



For information on handling electronic waste, see www.sandberg.world/weee